

Airwheel C5 USER MANUAL

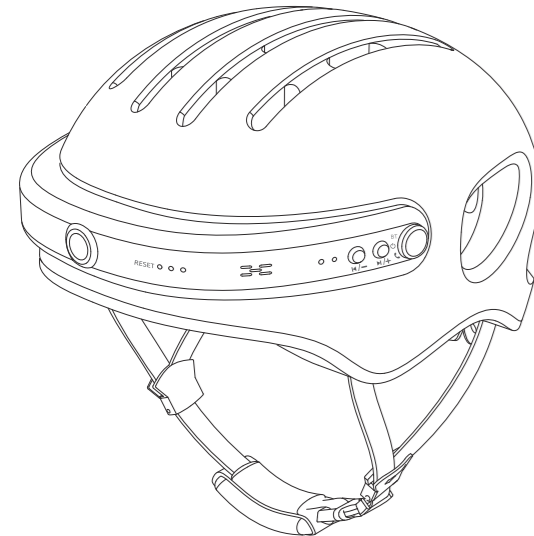

Check Packing Contents

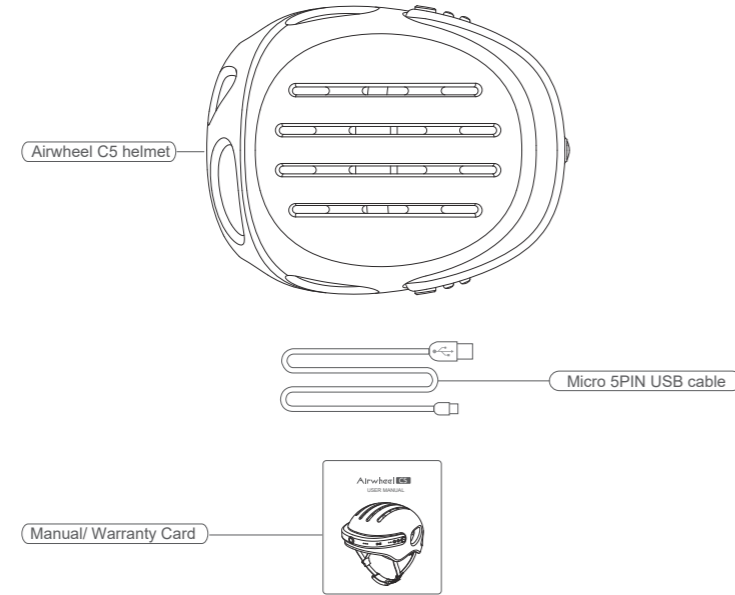

Packing list

Airwheel C5 helmet	1 pcs	Manual/ Warranty Card	1 unit
Micro 5PIN USB cable	1 pcs	SD Card/Card Reader	Optional Accessory

Helmet specification

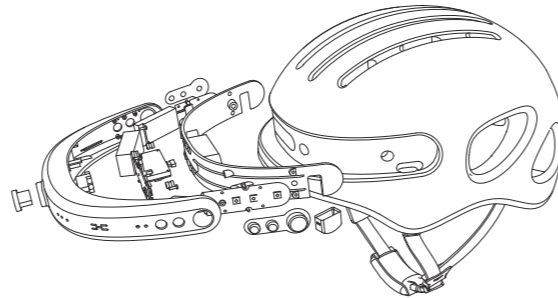

Appearance		Camera lens	
Size	272mm × 220mm × 169mm	Video max resolution	2304*1296P 30fps
Weight	440g	Video format	MOV
Applicable Head Circumference	L Size: 53-58cm XL Size: 59-63cm	Photo resolution	1920*1080 (2M)
Memory/extension		Photo format	JPEG
Internal memory	8MB NOR FLASH	Camera lens	6G Wide-angle HD lens
Internal cache	512Mb DDR2(Internal)	Coms sensor	OV4689 1/3" CMOS
External memory	Micro SD Card (Max. support 128GB)	Viewing Angle	diagonal angle150° horizontal angle130° vertical angle67.4°
Battery			
Type	Li-polymer	Charging voltage	5V
Battery capacity	2000mAh	Charging current	500mA
Maximum power dissipation	450mA/4.2V	Charging time	about 3 hours
Hours of use	about 4 hours		

Functional diagram

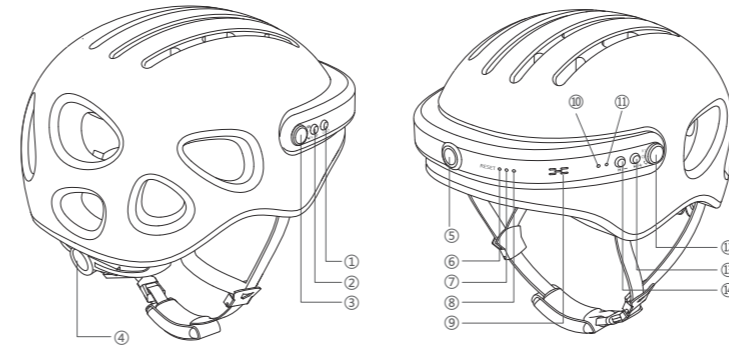

- ① DV switch -----Long press to turn on/off the camera
- ② Wi-Fi pairing ----- Wi-Fi on/off
- ③ Start/stop key ----- Taking photos or shooting videos
- ④ Helmet adjuster ----- Adjusting the helmet size
- ⑤ Camera ----- Support
- ⑥ Reset ----- Shut off compulsively
- ⑦ LED indicator ----- Power on in green light, WIFI in blue light, charging in red light
- ⑧ DV microphone ----- Support
- ⑨ Prompt tone ----- Support
- ⑩ Bluetooth LED -----Flashing frequently when not connected, solid blue light when connected, flashing slowly when playing music or shooting videos.
- ⑪ Bluetooth microphone --- Support
- ⑫ Bluetooth switch ----- Turn on/off the Bluetooth, Answer/hang up the phone call
- ⑬ Short press Next song/long press volume +
- ⑭ Short press Last song/long press volume -

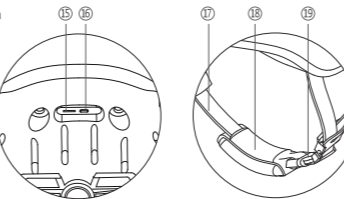

- ⑮ SD card slot -----Maximum support 128GB
- ⑯ Micro USB port ----- Read image data in SD card or charge the helmet
- ⑰ Helmet drawingstring --- Fasten the helmet
- ⑱ Chin pad ----- Keep comfortable
- ⑲ Drawstring buckle --- Fasten the drawingstring

Safety

Please make sure this manual is read through and fully understood before initial use of Airwheel C5.

Important Notes:

Please check the following matters before wearing the C5 helmet:

- 1.Check if there is crack, scratches, rugged surface or abrasion in appearance and the integrity of cap lining etc. which might affect the performance of the helmet. Please repair or dump it in time when it is not in good condition;
- 2.Check if all components are fastened;
- 3.Check if all the functional modules are in good condition, whether there is enough battery capacity.

Attention:

- 1.Do not wear C5 in rainy days;
- 2.Do not clean C5 with water, as it may cause shortcut or electrical function failure;
- 3.Do not clean C5 with detergent, as it may cause damage to the EPS;
- 4.Changing or removing any of the original accessories are forbidden;
- 5.Do not wear C5 once it has experienced a big impact and has a crack;
- 6.Do not wear C5 when riding motorcycles;
- 7.Do not wear C5 in engineering work, as it cannot replace the Safety Helmet.

Please read this manual carefully before use. Wearing C5 in the right way can prevent your head from serious injury by absorbing and spreading the impact energy. However, not all kinds of injuries can be prevented by the helmet. It may cause physical injury or property loss to the user or a third party if you are not following the user manual or traffic laws and regulation. The Airwheel Company is only responsible for the malfunction of the helmet, and is NOT responsible for any physical injury or property loss to the user while using this product.

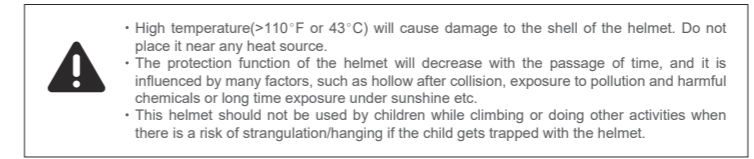

Cleaning:

Please use a soft cloth dipped with a little alcohol to wipe the helmet shell, inside liner, fixed system and other accessories. Please use the lens cloth to wipe the lens gently.

Storage:

This helmet should be stored in the dry and ventilated places at room temperature. It needs to be fully charged for at least one time every month.

How to wear

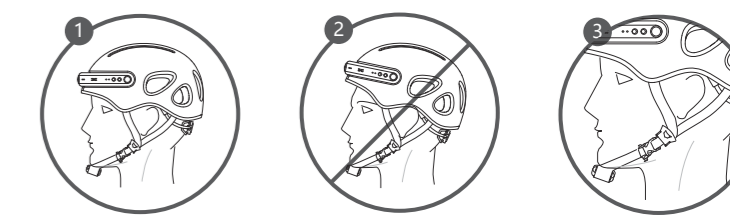

1. The right way to wear the helmet, below forehead.
2. The wrong way to wear helmet, above forehead.
3. Place the centre of the side strap below your ears to make sure it is comfortable for the ears.

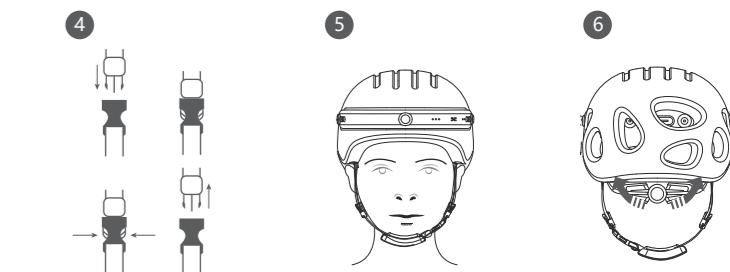

4. Fasten the buckle and adjust the length of the straps.
5. Adjust the chin pad to keep comfortable.
6. Helmet size can be adjusted by the helmet adjuster, tighten it clockwise or loosen it anticlockwise.

Usage

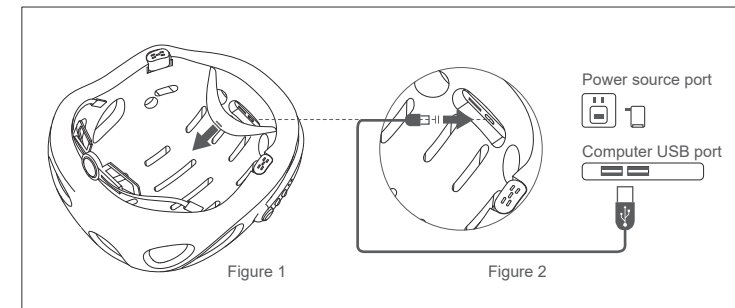

1. Open the front lining of the helmet (as Figure 1 shows), connect the Micro 5PIN USB cable with power source (power adapter or computer USB port) to charge. For first usage, see Figure 2.

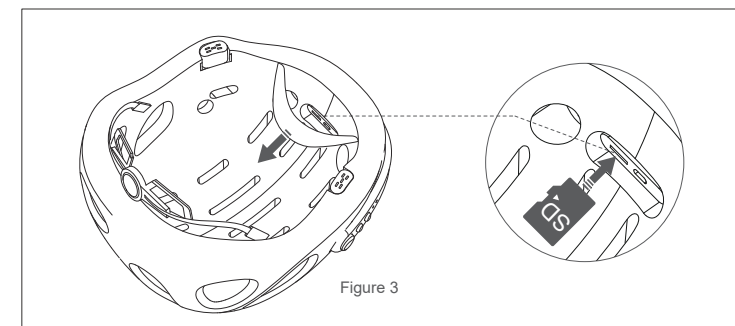

2. As Figure 3 shows, pull open the lining, insert the SD card in the arrow direction until it does not pop out, and then push the SD card to take out.

Bluetooth connection

1. Long press the Bluetooth switch . It means successfully connected when hearing the prompt tone and the light is flashing blue.
2. Access to phone setting, Turn on the Bluetooth, go to Bluetooth search page, click C5 to connect, solid blue light in the indicator when successfully connected.

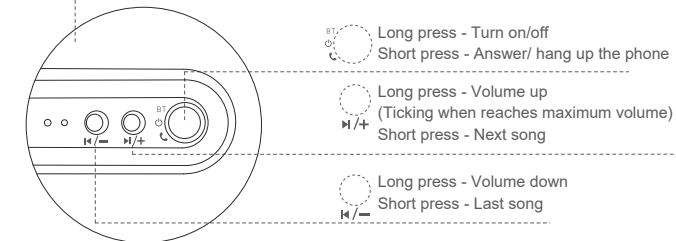
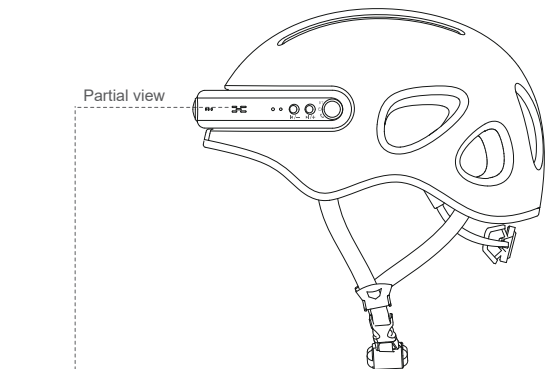

3. When successfully connected, short press the key to answer the phone call, short press it again to hang up.

DV connection

1. Long press the switch key. It means successfully connected when hearing the prompt tone and the light is solid green.
2. Short press to take photos, long press to shoot videos and long press again to stop.

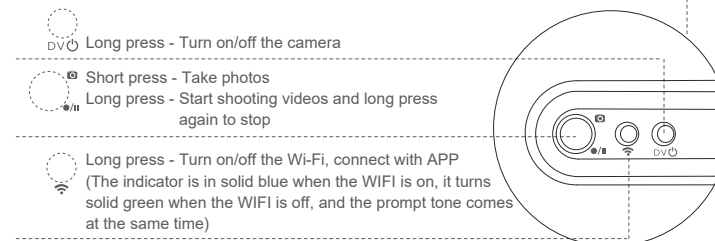
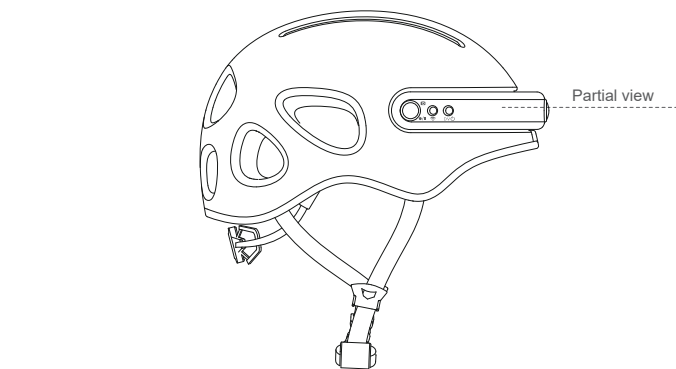

3. Long press key and turn on the helmet Wi-Fi (the indicator is solid blue and there is prompt tone), Connect the APP.

Download APP



Scan QR code to download

Note: support Android 4.3 or later, support IOS 7.0 or later

Instructions :

1. Turn on the C5 helmet, turn on the helmet Wi-Fi and start the APP.
2. operate as the following steps to connect (Password: 1234567890).
3. For detailed information, please visit Airwheel official website or give a call to consult.

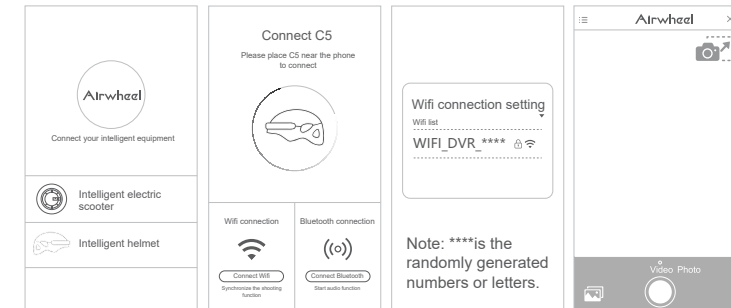

1. Start the APP and choose "Smart helmet" in the list.
2. Click wireless icon and search the Airwheel models nearby (note: click to connect the Bluetooth)
3. Click WIFI_DVR_**** and input the password "1234567890".
4. After successful connection, go back to the home page of the APP to take photos or shoot videos.

After sale

Please keep the warranty card and invoices properly as after-sales credential. C5 will provide the following after-sales services providing not damaged by the users.

After-sales Service

The C5 helmet will be guaranteed for one year.

Following circumstances are not included in the free repairing scope.

1. Malfunction caused by the users who are not following the instructions on the User Manual.
2. Damage caused by users' self-refit and self-repair, malfunction due to not complying with the terms of use.
3. Failure caused by users' improper keeping or accidents.
4. No warranty card or invoice; or there is discrepancy between the vehicle, warranty card and invoice.
5. The appearance damage after using does not belong to the warranty scope.
6. Self-demolition parts are excluded from the User Manual.
7. Damage caused by long time wearing in the rain and soaking in water.



Doc. No. : V2.1